

SECTION THROUGH TAPER TOP

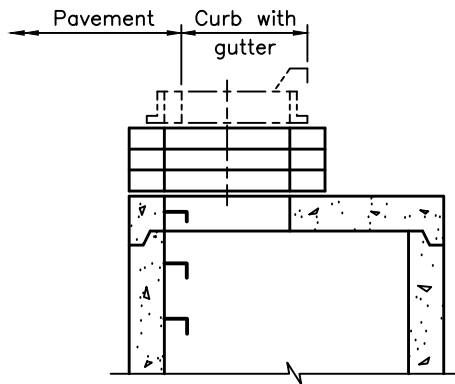

SECTION THROUGH FLAT CAP

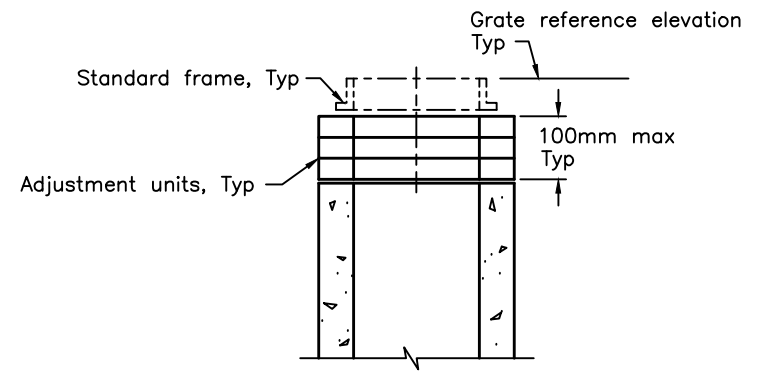

SECTION THROUGH CATCH BASIN

Adjustment units for maintenance holes with round openings. Flat or sloped adjustment units are available in sections or continuous units.

Note 1, Typ

Taper top

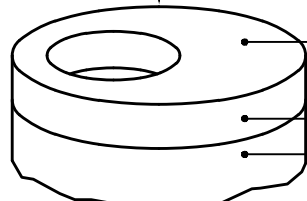
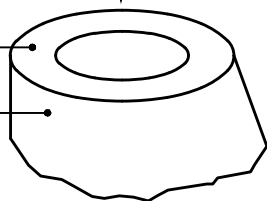
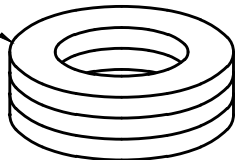

Note 1, Typ

Flat cap

Riser section

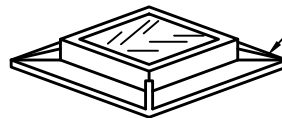

Round or square frame with grate or cover

Note 1, Typ

Adjustment units for catch basins with square openings. Flat or sloped adjustment units are available in sections or continuous units.

Flat or sloped adjustment units are available in sections or continuous units.

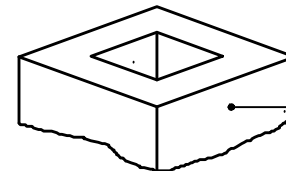
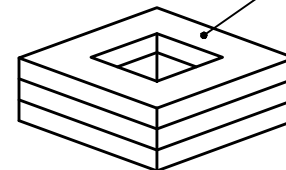

Catch basin

NOTES:

- 1 Adjustment units shall be bonded to the structure and each other as per manufacturer's recommendations.
- A Installation and sealing of adjustment units and frame shall be according to adjustment unit manufacturer's recommendations.
- B Adjustment units shall not extend beyond the outside edge of the structure.
- C All dimensions are in millimetres unless otherwise shown.

ONTARIO PROVINCIAL STANDARD DRAWING

Nov 2018

Rev 2

**HIGH DENSITY POLYETHYLENE
ADJUSTMENT UNITS FOR MAINTENANCE HOLES,
CATCH BASINS, AND VALVE CHAMBERS**

OPSD 704.011

