

FRAME PLAN

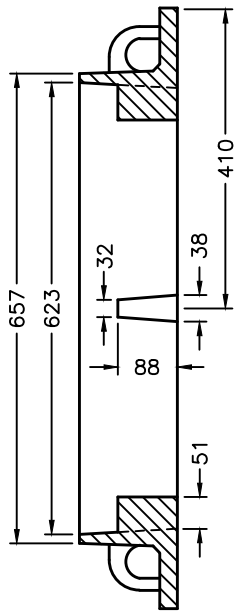

SECTION A-A

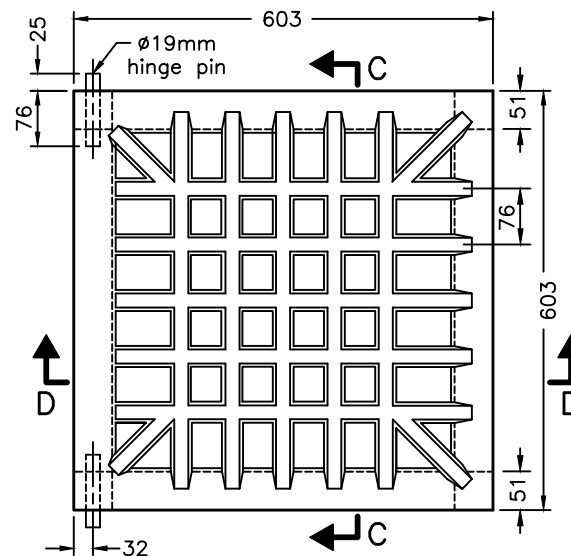

GRATE PLAN

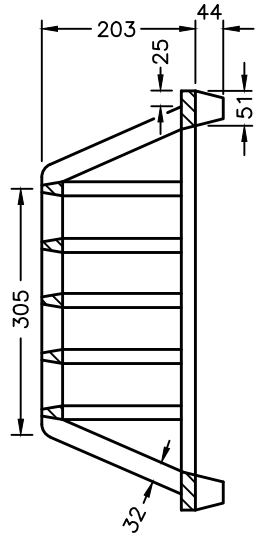

SECTION C-C

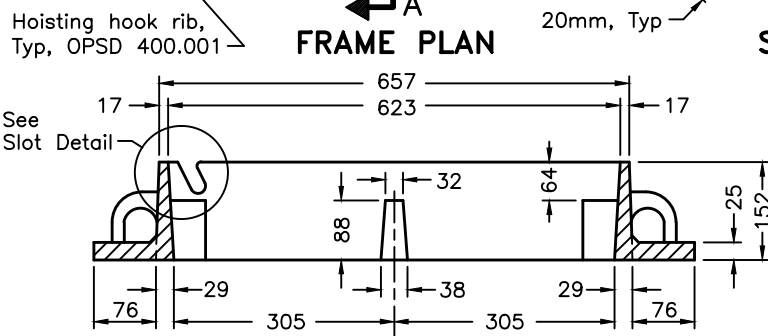

SECTION B-B

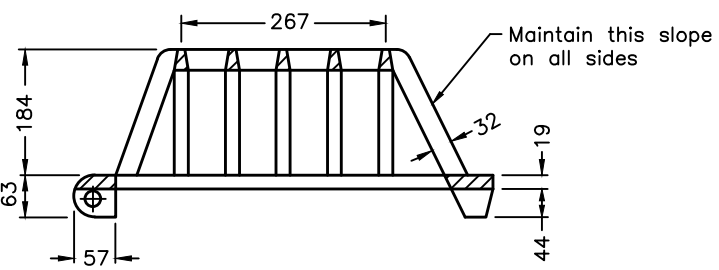

SECTION D-D

See Slot Detail

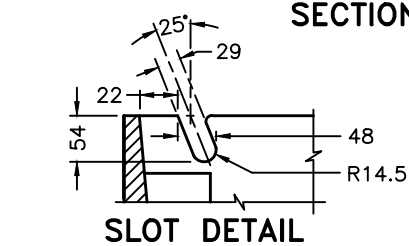

SLOT DETAIL

NOTES:
A All dimensions are in millimetres unless otherwise shown.

ONTARIO PROVINCIAL STANDARD DRAWING	Nov 2018	Rev 3	
CAST IRON, SQUARE FRAME WITH BIRDCAGE GRATE FOR CATCH BASINS			
OPSD 400.120			